



## ADVANCED MANUAL

VHF TRANSCEIVER  
**IC-V86**  
UHF TRANSCEIVER  
**IC-U86**

### INTRODUCTION

1 ACCESSORIES

2 BATTERY CHARGE

3 ADVANCED OPERATION

4 REPEATER AND DUPLEX OPERATION

5 MEMORY/CALL OPERATION

6 SCAN OPERATION

7 TONE SQUELCH AND POCKET BEEP

8 DTMF MEMORY

9 SET MODES

10 PROGRAMMING

11 RESETTING

12 TROUBLESHOOTING

13 OPTIONS

---

# INTRODUCTION

Thank you for choosing this Icom product. This product was designed and built with Icom's state of the art technology and craftsmanship. With proper care, this product should provide you with years of trouble-free operation.

---

## IMPORTANT

---

**READ ALL INSTRUCTIONS** carefully and completely before using the transceiver.

**SAVE THIS INSTRUCTION MANUAL** — This instruction manual contains advanced operating instructions for the IC-V86/IC-U86. For basic operating instructions, see the **BASIC MANUAL**.

---

## EXPLICIT DEFINITIONS

---

WORD	DEFINITION
<b>⚠ WARNING!</b>	Personal injury, fire hazard or electric shock may occur.
<b>CAUTION</b>	Equipment damage may occur.
<b>NOTE</b>	If disregarded, inconvenience only. No risk of personal injury, fire or electric shock.

---

## FEATURES

---

- Rugged construction (IP54 and MIL-STD-810G)
  - ① Only when the battery pack or case, antenna, and jack cover or optional HM-168LWP, HM-222HLWP, HS-94LWP, HS-95LWP are attached.
- Powerful 7 W of output power (Extra High power)
  - ① 5.5 W for IC-U86.
- Extend Battery Life function (With the BC-240)

Icom, Icom Inc. and the Icom logo are registered trademarks of Icom Incorporated (Japan) in Japan, the United States, the United Kingdom, Germany, France, Spain, Russia, Australia, New Zealand, and/or other countries. All other products or brands are registered trademarks or trademarks of their respective holders.

Icom is not responsible for the destruction, damage to, or performance of any Icom or non-Icom equipment, if the malfunction is because of:

- Force majeure, including, but not limited to, fires, earthquakes, storms, floods, lightning, other natural disasters, disturbances, riots, war, or radioactive contamination.
- The use of Icom transceivers with any equipment that is not manufactured or approved by Icom.

# Section 1 ACCESSORIES

---

Supplied accessories.....	1-2
Antenna .....	1-2
Belt clip .....	1-2
Battery pack or case.....	1-3
Jack cover .....	1-3

## Supplied accessories

Battery pack

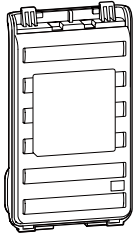

Antenna

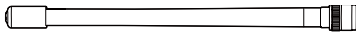

Jack cover  
(with screws)

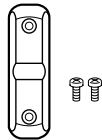

Belt clip



Battery charger



Power adapter

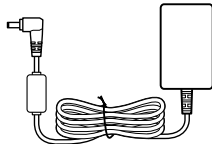

**NOTE:** Some accessories are not supplied, or the shape is different, depending on the transceiver version.

## Antenna

Insert the antenna into the antenna connector and rotate the antenna base to lock it in place.

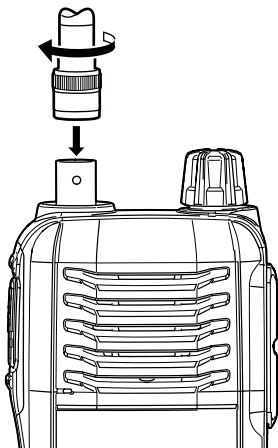

### CAUTION:

- **NEVER HOLD** just the antenna when carrying the transceiver.
- **DO NOT** transmit without an antenna.

## Belt clip

### To attach the belt clip:

- Slide the belt clip in the direction of the arrow until the belt clip locks in place, and makes a 'click' sound.

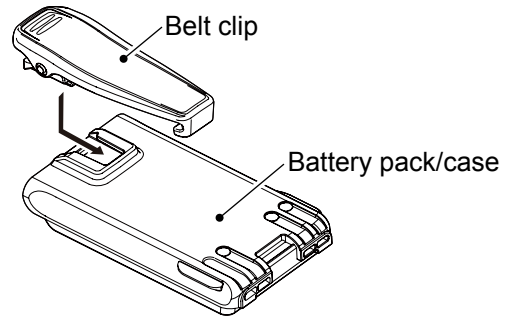

### To detach the belt clip:

1. Remove the battery pack or case from the transceiver, if it is attached.
2. Lift the tab up (1), and slide the belt clip in the direction of the arrow (2).

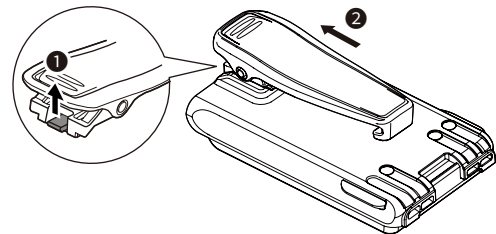

## Battery pack

**CAUTION:** When the battery case is attached, the Battery Protection function must be turned OFF in the Initial Set mode. (p. 9-7)

### To attach:

1. Insert the battery pack in the direction of the arrow (1), then close.
2. Hook the latch until it makes a 'click' sound (2).

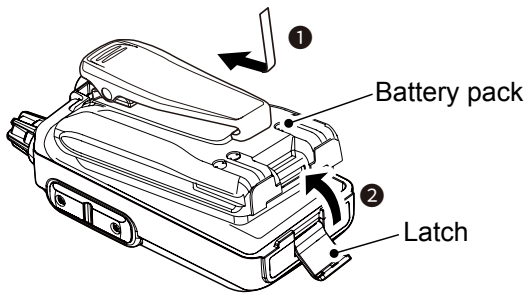

### To detach:

**⚠ WARNING!** The latch is tightly locked, so use caution when releasing it. **DO NOT** use your fingernail. Use the edge of a coin or screwdriver tip to carefully release it.

- Unhook the latch (1), and then lift up the battery pack in the direction of the arrow (2).

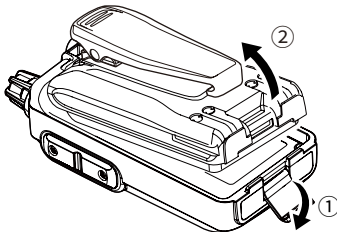

**CAUTION: NEVER** detach or attach the battery pack when the transceiver is wet or soiled. This may result in water or dust getting into the transceiver or the battery pack, and may result in them being damaged.

**NOTE:** Keep battery terminals clean. It's a good idea to occasionally clean them.

## Jack cover

Attach the jack cover when optional equipment is not used.

### To attach the jack cover

1. Attach the jack cover to the [SP MIC] jack (1).
2. Insert and tighten the screws (2).

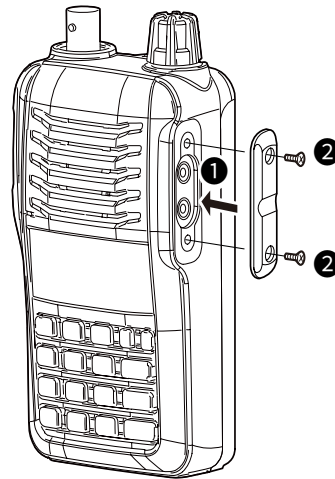

### To detach the jack cover

1. Remove the screws with a phillips screwdriver (1).
2. Detach the jack cover to connect optional equipment (2).

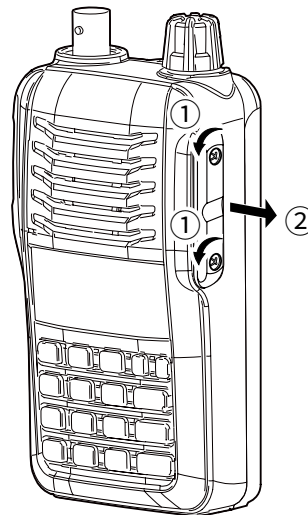

## Section 2 BATTERY CHARGE

---

Battery chargers .....	2-2
◇ Using the BC-191 to rapid charge the BP-264 .....	2-2
◇ Using the BC-192 to regular charge the BP-264 .....	2-2
◇ Using the BC-240 to rapid charge the BP-298/BP-299 .....	2-3

## Battery chargers

### ◇ Using the BC-191 to rapid charge the BP-264

The BC-191 provides rapid charging of only the BP-264 Ni-MH battery pack. Never use it to charge any other battery pack.

**Charging time:** Approximately 2 hours

**Additionally needed item (purchase separately):**

A power adapter (not supplied with some transceiver versions) or the OPC-515L or CP-23L DC power cable.

- ① A power adapter may a different type, or no power adapter is supplied, depending on the transceiver version.
- ① The optional OPC-515L (for a DC power source) or CP-23L (for a 12 V cigarette lighter socket) can be used instead of the power adapter.

**NOTE:** When the BC-191's charging indicator lights as below, it indicates the following states.

- Lights orange: While charging
- Lights green: When charging is completed.

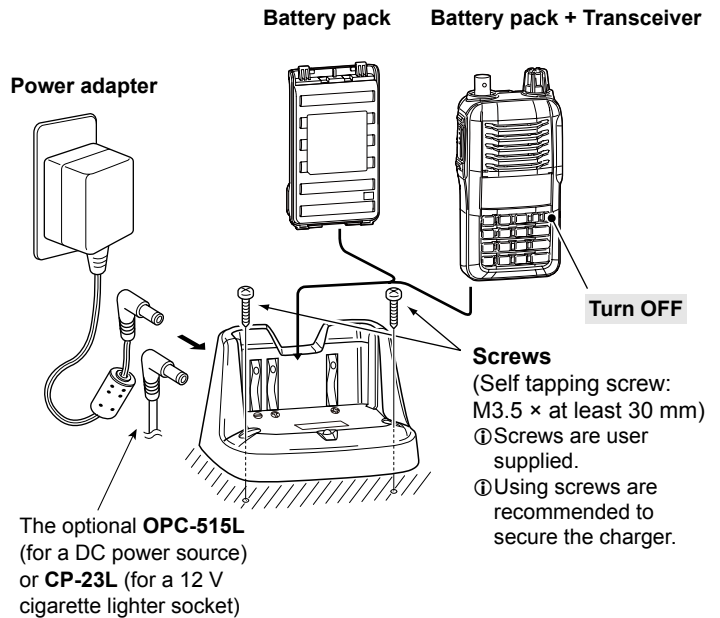

### ◇ Using the BC-192 to regular charge the BP-264

The BC-192 provides regular charging of only the BP-264 Ni-MH battery pack. Never use it to charge any other battery pack.

**Charging time:**

- At 12 V: Approximately 36 hours
- At 13.8 V: Approximately 21 hours
- At 16 V: Approximately 16 hours

- ① Charging time period differs, depending on the input voltage.

**Additionally needed item (purchase separately):**

A power adapter (not supplied with some transceiver versions) or the OPC-515L DC power cable.

- ① A power adapter may a different type, or no power adapter is supplied, depending on the transceiver version.
- ① The optional OPC-515L (for a DC power source) can be used instead of the power adapter.

**NOTE:** When the BC-192's charging indicator lights as below, it indicates the following state.

- Lights green: While charging.
- ① The charge indicator will not go out even after a battery pack is fully charged.

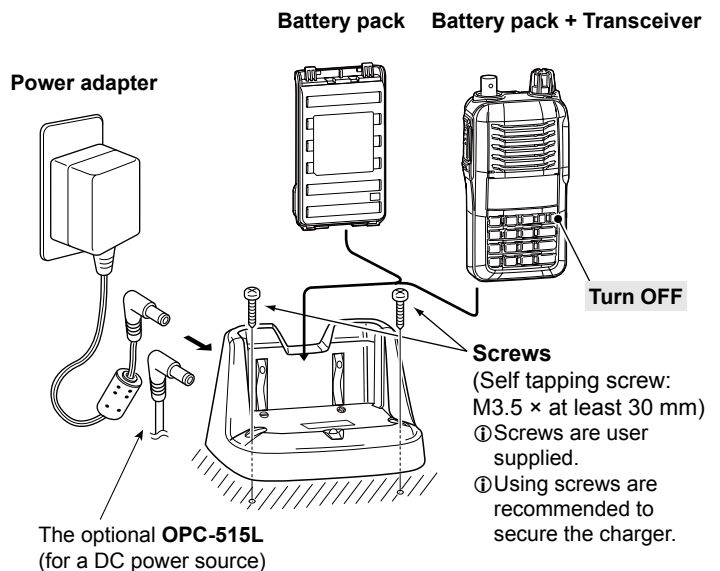

### Battery chargers

#### ◇ Using the BC-240 to rapid charge the BP-298/BP-299

The BC-240 provides rapid charging of only the BP-298/BC-299 Li-ion battery pack. Never use it to charge any other battery pack.

#### Charging time\*

With the BP-298: Approximately 3 hours

With the BP-299: Approximately 4.6 hours

\* When the Extend Battery Life function is turned OFF.  
See the BASIC MANUAL for details.

#### Additionally needed item (purchase separately):

A power adapter (not supplied with some transceiver versions) or the OPC-515L or CP-23L DC power cable.

- ① A power adapter may be a different type, or no power adapter is supplied, depending on the transceiver version.
- ① The optional OPC-515L (for a DC power source) or CP-23L (for a 12 V cigarette lighter socket) can be used instead of the power adapter.

**CAUTION:** When using the OPC-515L DC power cable **NEVER** connect the OPC-515L to a power source using reverse polarity. This will ruin the battery charger. White line: ⊕ Black line: ⊖

**NOTE:** When the BC-240's charging indicator lights or blinks as below, it indicates the following states.

- Lights orange: While charging
- Lights green: When charging is completed.
- Blinks red: When a charging error has occurred. Reinstall the battery or the transceiver.

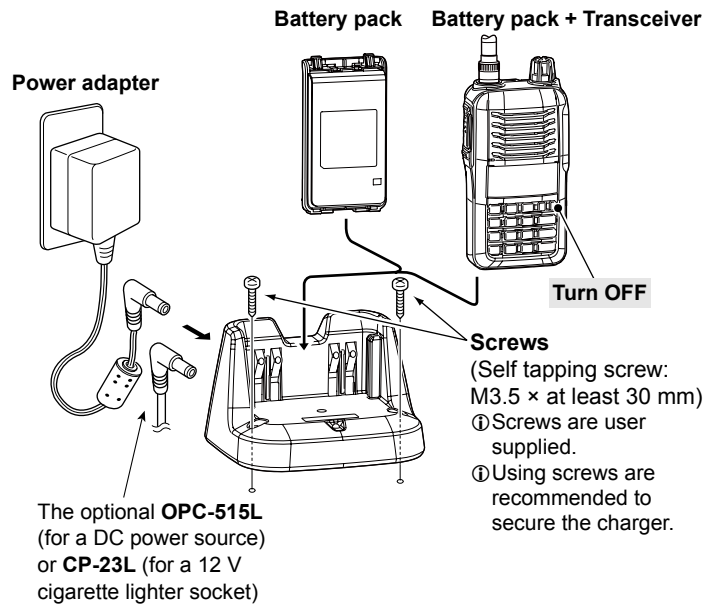



## Section 3

## ADVANCED OPERATION

---

Adjusting the audio level.....	3-2
Selecting passband width.....	3-2
Receiving.....	3-2
Transmitting.....	3-2
[VOL] function assignment.....	3-3
Weather channel operation (For only the USA version of IC-V86).....	3-4
◇ Weather channel selection.....	3-4
◇ Weather Alert function.....	3-4

## Adjusting the audio level

- Rotate [VOL]\* to adjust the audio level.
  - The display shows the audio level while adjusting.
  - ① If the squelch is closed, hold down [MONI] while adjusting the audio level.

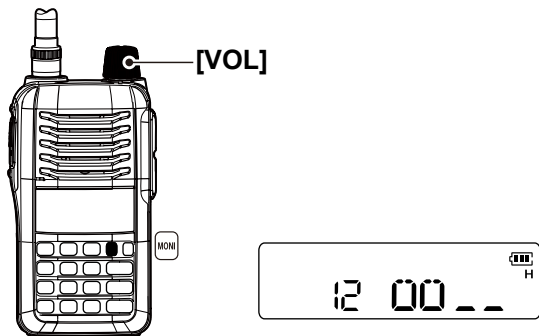

\* Use [VOL] or [▲]/[▼], depending on the setting of the “Dial assignment” in the Initial Set mode. (p. 9-6)

## Selecting passband width

Set both the transmission and reception passband width to wide or narrow.

1. Push [FUNC], and then push [SET] to enter the Set mode.
2. Push [▲] or [▼] to select the passband width item (W/n).
3. Rotate [VOL] to select the passband width.
  - “W”: Wide (FM mode)
  - “n”: Narrow (FM-N mode)
4. Push [# ENT] to exit the Set mode.

### The “Passband width” item in the Set mode



(FM mode is selected)



(FM-N mode is selected)

## Receiving

1. Rotate [VOL]\* to adjust the desired audio level, as described to the left.
  - The display shows the audio level while adjusting.
2. Adjust the squelch level.
  - The display shows the squelch level while adjusting.
  - ① While holding down [MONI], push [▲] or [▼]\* several times to adjust the squelch level.
  - ② “SqL 1” is loose squelch (for weak signals) and “SqL 10” is tight squelch (for strong signals). “SqL 0” is open squelch.
3. Set the operating frequency or memory channel.
4. When you receive a signal, the squelch opens and audio can be heard.
  - The signal icon shows the relative signal strength of the received signal.

\* Use [VOL] or [▲]/[▼], depending on the setting of the “Dial assignment” in the Initial Set mode. (p. 9-6)

## Transmitting

**CAUTION: DO NOT** transmit without an antenna.

**NOTE:** To prevent interference, listen on the channel before transmitting by opening the squelch. To open the squelch, hold down [MONI].

1. Set the operating frequency or memory channel.
  - Adjust the output power if desired. See the BASIC MANUAL for the details.
2. Hold down [PTT] to transmit.
  - “TX” is displayed while transmitting.
  - ① The signal icon shows the output power level.
3. Speak into the microphone at your normal voice level.
  - ① DO NOT hold the transceiver too close to your mouth, or speak too loudly. This may distort the signal.
4. Release [PTT] to receive.

**NOTE:** When the TX permission is set to OFF, you cannot transmit. (p. 9-3)

**⚠ WARNING!** When using the BP-263 BATTERY CASE, frequent or continuous transmissions can cause the batteries to overheat, and may cause a burn. Be careful of long transmissions when the Time-out Timer function is turned OFF, or set to a long time period.

① We recommend using the Mid or Low power setting.

## [VOL] function assignment

[VOL] can be used as a tuning control instead of [▲] and [▼], to suit your preference. However, when [VOL] functions as a tuning control, [▲] and [▼] function as volume controls.

1. Hold down [⏻] for 1 second to turn OFF the power.
2. While holding down [▲] and [▼], turn ON the power to enter the Initial Set mode.
3. Push [▲] or [▼] to select the dial assignment item (tOP).
4. Rotate [VOL] to select an option.
5. Push [# ENT] to exit the Initial Set mode.

[VOL] and [▲]/[▼] function as described below, depending on the option.

Option	[VOL]	[▲]/[▼]
tOP.VO	Volume control	Tuning controls
tOP.di	Tuning control	Volume controls

### The “Dial assignment” item in the Set mode



[VOL] functions as the volume control.



[VOL] functions as the tuning control.

## Weather channel operation (For only the USA version of IC-V86)

There are 10 weather channels for monitoring weather broadcasts from NOAA (National Oceanic and Atmospheric Administration).

### ◇ Weather channel selection

1. Push [VFO/MR/CALL] several times to select the weather channel mode.
2. Push [▲] or [▼] to select the desired weather channel.
3. Push [VFO/MR/CALL] to return to the VFO, memory or Call channel mode.

### ◇ Weather Alert function

NOAA broadcast stations transmit weather alert tones before important weather announcements. When the Weather Alert function is turned ON, the transceiver checks the selected weather channel every 5 seconds for an announcement. When the alert signal is detected, the "ALt" and the WX channel are displayed alternately and a beep tone sounds until the transceiver is operated. The selected (used) weather channel is checked periodically while in standby, or while scanning.

1. Select the desired weather channel.  
(See the above topic.)
2. Push [FUNC], and then push [SET] to enter the Set mode.
3. Push [▲] or [▼] to select the weather alert item (ALt).
4. Rotate [VOL] to select "ON," to turn ON the Weather Alert function.
5. Push [# ENT] to exit the Set mode.
6. Set the desired stand-by mode.
  - Select the VFO, memory channel or Call channel.
  - Scan or priority watch operation can be also selected.
7. When the alert is detected, a beep sounds and "ALt" and the weather channel number is alternately displayed.
8. Turn OFF the Weather Alert function in the Set mode.

**NOTE:** While receiving a signal on a frequency other than the weather channel, the receiving audio will be momentarily interrupted approximately every 5 seconds, when the Alert function is turned ON. This is caused by the Weather Alert function. To cancel these interruptions, turn OFF the Weather Alert function in the Set mode.

While in the weather channel mode, push [FUNC], and then push [SCAN] to start a weather channel scan. To stop the scan, push any key except [▲]/[▼], [FUNC] and [MONI].

Push  several times to select the weather



Push  or  several times to select the weather



The "Weather alert" item in the Set mode

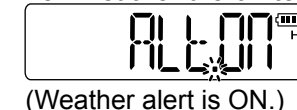

Weather channel mode display



↑ Alternately displays these indications.

When the alert is detected



## Section 4

# REPEATER AND DUPLEX OPERATION

---

Accessing a repeater.....	4-2
DTCS encoder (Only TX) .....	4-3
Lockout function .....	4-3
Auto Repeater function (For only the USA version of IC-V86) .....	4-4

## Accessing a repeater

When using a repeater, the transmit frequency is shifted from the receive frequency by the frequency offset. (p. 9-2) This is called duplex operation. It is convenient to program repeater information into memory channels.

1. Set the receive frequency (the repeater output frequency).
  - **For only the USA version of IC-V86:**  
When the Auto Repeater function is ON, steps 2 and 3 are not necessary.
2. Push [FUNC], and then push [DUP] several times to select minus duplex or plus duplex. (“-” or “+”)
3. Push [FUNC], and then push [TONE] several times to turn ON the subaudible tone encoder, depending on the repeater requirements.
  - “J” is displayed.
  - ① The subaudible tone frequency can be set in the Set mode.
4. Hold down [PTT] to transmit.
  - The displayed frequency automatically changes to the transmit frequency (repeater input frequency).
  - ① If “OFF” is displayed, confirm that the frequency offset is correctly set.
5. Release [PTT] to receive.
6. Hold down [MONI] to check whether you can directly receive the signal from the other station.
  - ① When the other station’s signal can be directly received, move to a non-repeater frequency to use simplex. (duplex OFF)

**For only the USA version of IC-V86:**  
Auto Repeater function uses standard repeater tone frequencies and frequency offsets.

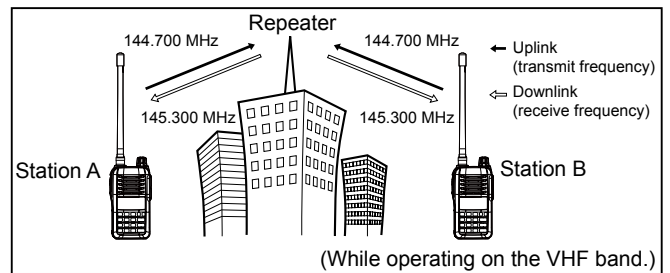

Setting the shift direction of the transmit frequency

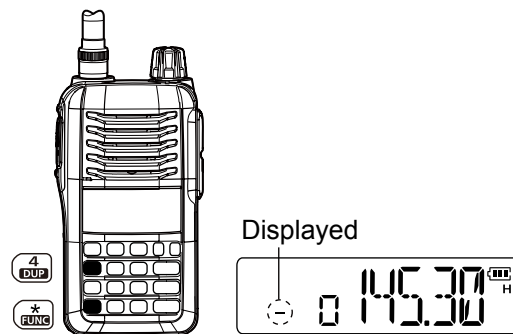



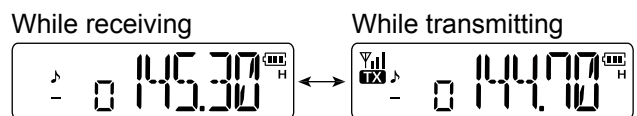
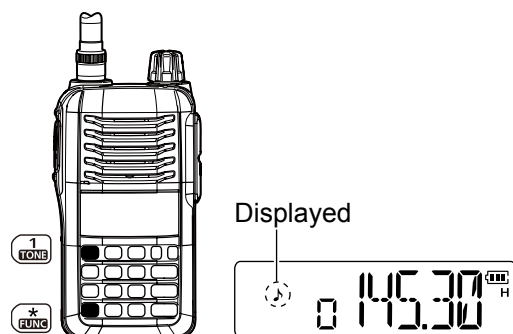

Turning ON the subaudible tone encoder



## DTCS encoder (Only TX)

The DTCS encoder superimposes the selected DTCS code over your transmitted signal.

1. Push [FUNC], and then push [SET] to enter the Set mode.
2. Set the DTCS code and polarity, in the same way you set the DTCS squelch. (p. 7-2)
  - ① You can set the DTCS transmit and receive polarity, but the DTCS encoder affects only transmit.
3. Push [# ENT] to exit the Set mode.
4. Push [FUNC], and then push [TONE] several times, until both “” and “” are displayed.
  - The DTCS encoder is activated.



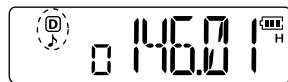

Push , and then push  several times to turn ON the DTCS encoder.



DTCS encoder (Only TX)

## Lockout function

This function helps prevent interference to other stations by inhibiting transmitting when a signal is received. The transceiver has two inhibiting modes, repeater and busy.

1. Hold down  for 1 second to turn OFF the transceiver.
2. While holding down  and , turn ON the transceiver to enter the Initial Set mode.
3. Push  or  to select the lockout item (RLO).
4. Rotate [VOL] to select the Lockout function option of “RP,” “bU” or “OF.”
  - “RLO.OF”: The Lockout function is OFF.
  - “RLO.RP”: The transmit is inhibited when a signal with an unmatched subaudible tone is received.
  - “RLO.bU”: Transmit is inhibited when a signal is received.
5. Push [# ENT] to exit the Initial Set mode.

### The “Lockout” item in the Initial Set mode



(The Repeater Lockout function is OFF.)



(The Repeater Lockout function is ON.)



(The Busy Lockout function is ON. )

## Auto Repeater function (For only the USA version of IC-V86)

The USA version of IC-V86 automatically activates the repeater settings (DUP– or DUP+ and tone encoder ON/OFF), when the operating frequency falls within the general repeater output frequency range. It deactivates them when outside of the range.

1. Hold down [P] for 1 second to turn OFF the power.
2. While holding down [▲] and [▼], turn ON the power to enter the Initial Set mode.
3. Push [▲] or [▼] to select the Auto Repeater item (RPt).
4. Rotate [VOL] to set the Auto Repeater function to "R1," "R2" or "OF."
  - "RPt.OF": The Auto Repeater function is OFF.
  - "RPt.R1": The Auto Repeater function is ON (For only duplex).
  - "RPt.R2": The Auto Repeater function is ON (For duplex and tone encoder).
5. Push [# ENT] to exit the Initial Set mode.

### Frequency range and offset direction

Frequency range	Duplex direction
145.200–145.495 MHz 146.610–146.995 MHz	"–" is displayed.
147.000–147.395 MHz	"+" is displayed.

### The "Auto repeater" item in the Initial Set mode



Auto Repeater function is OFF.



Auto Repeater function is ON  
(For only duplex).



Auto Repeater function is ON  
(For duplex and tone encoder).



# Section 5

# MEMORY/CALL OPERATION

---

General description .....	5-2
Copying memory/Call contents.....	5-2
◇ Memory/Call channel to VFO.....	5-2
◇ Memory/Call to memory/Call .....	5-3
Clearing memory contents.....	5-4
Display type .....	5-5
Programming channel names.....	5-6
◇ Setting the display type.....	5-6
◇ Programming a channel name.....	5-6
◇ Selectable characters .....	5-6

## General description

The transceiver has 207 memory channels, including 6 scan edge memory channels (3 pairs: 1A/b, 2A/b, and 3A/b), and 1 Call channel (C). These channels can be individually programmed with:

- Operating frequency
- Passband width (p. 3-2)
- Duplex direction (+ or -) with frequency offset
- Reversed Duplex function ON/OFF
- Subaudible tone encoder, tone squelch, or DTCS squelch ON/OFF
- Subaudible tone frequency, CTCSS tone frequency, or DTCS code with polarity
- Skip setting (p. 6-3)
- Tuning step
- Output power
- TX permission (p. 9-3)

## Copying memory/Call contents

This function copies a memory channel's contents to the VFO, another memory or the Call channel. This function is useful for easy recalling the frequency offset, subaudible tone frequency, and so on.

### ◇ Memory/Call channel to VFO

1. Push [VFO/MR/CALL] several times to select the memory mode or Call channel mode.
  - **For memory channel:**  
Push [▲] or [▼] to select the memory channel to be copied.
2. Push [FUNC], and then hold down [VFO/MR/CALL] for 1 second.
  - The VFO mode is automatically selected.

#### Example: Copying memory channel 11 contents to the VFO mode.

Push ▲ or ▼ to select channel 11.



Push [FUNC], and then hold down [VFO/MR/CALL] for 1 second.

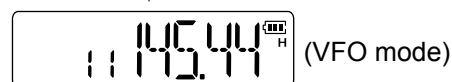
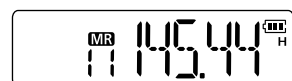

Copying memory/Call contents

◇ Memory/Call to memory/Call

1. Push [VFO/MR/CALL] several times to select the memory mode or Call channel mode.
  - **For memory channel:**  
Push [▲] or [▼] to select the memory channel to copy.
2. Push [FUNC], and then push [VFO/MR/CALL].
  - "MR" and "--" blink.
  - ① Do not hold down [VFO/MR/CALL] for more than 1 second, otherwise the memory contents will be copied to the VFO mode.
3. Push [▲] or [▼] to select the target memory or Call channel.
  - ① To cancel programming, push [VFO/MR/CALL] before doing step 3.
4. Push [FUNC], and then hold down [VFO/MR/CALL] for 1 second to copy the contents of selected memory, or the Call channel, to the target memory.

**Example: Copying memory channel 11 contents to channel 12.**

Push [▲] or [▼] to select channel 11.

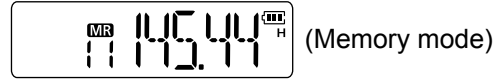

Push [FUNC], and then push [VFO/MR/CALL].



Push [▲] or [▼] to select channel 12.



Push [FUNC], and then hold down [VFO/MR/CALL] for 1 second.



## Clearing memory contents

Contents of programmed memories can be cleared (deleted).

1. Push [VFO/MR/CALL] several times to select the memory or Call channel mode.
  - **For only the USA version of IC-V86:**  
Select any mode other than the weather channel mode.
2. Push [FUNC], and then push [VFO/MR/CALL].
  - "MR" and "--" blink.
3. Push [▲] or [▼] to select the channel to be cleared.
  - Memory channels not yet programmed are blank.
4. Perform the following operation within 1.5 seconds, otherwise the transceiver returns to the memory mode without clearing memory.
  - ① Push [FUNC], and then momentarily push [VFO/MR/CALL].
  - ② Push [FUNC], and then hold down [VFO/MR/CALL] for 1 second
    - 3 beeps sound, and then the memory channel is cleared.
5. Push [VFO/MR/CALL] to return to the previous mode.

**BE CAREFUL!** The contents of cleared memories **CANNOT** be recalled.

### Example: Clearing memory channel 11.

Push and then push .



Push or to select channel 11.

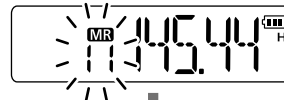

Perform the following operation within 1.5 seconds

Push , and then push , and push , and then hold down for 1 second again.

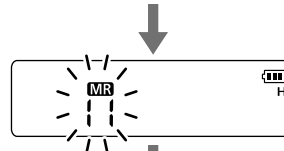

Push to return to the previous mode.

## Display type

The transceiver has 3 memory mode display types to suit your operating style. Select the Display type in the Initial Set mode. (p. 9-6)

### Frequency display

Displays the programmed frequency.

### Channel number display

Displays the memory channel number. Only programmed channels are displayed, and modes other than the memory mode cannot be selected.

**NOTE:** When the channel number display is selected, only the memory mode is selectable, and only the following functions can be used.

- Scan function
- Setting output power
- DTMF Memory function
- Key Lock function
- Setting of following items in the Set mode (pp. 9-2 ~ 9-4):

Scan resume setting, Function key timer, LCD backlight, VOX gain, MIC gain, VOX delay, VOX time-out timer, and DTMF TX key.

### Channel name display

Displays the channel name you have assigned. Only programmed channels are displayed.

- ① If no channel name is programmed, the programmed frequency will be displayed.
- ① Hold down [MONI] to check the programmed frequency.

**NOTE:** When the display type is “Channel name,” you must select the VFO mode to enter the Set mode.

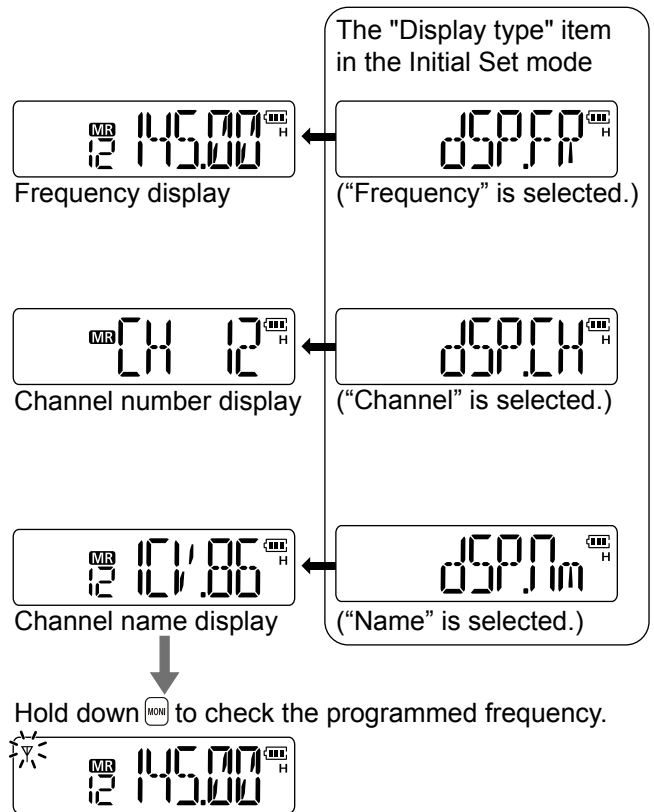

## Programming channel names

Each memory channel and the Call channel can be programmed with an alphanumeric channel name, for easy recognition. Names can be a maximum of 5 characters.

### ◇ Setting the display type

1. Hold down [⏻] for 1 second to turn OFF the transceiver.
2. While holding down [▲] and [▼], turn ON the power to enter the Initial Set mode.
3. Push [▲]/[▼] to select the display type item. (dSP)
4. Rotate [VOL] to select “dSP.nm.”
5. Push [# ENT] to exit the Initial Set mode.

The “Display type” item in the Initial Set mode

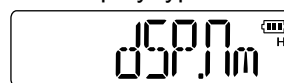

(“Name” is selected)

### ◇ Programming a channel name

1. Select the channel name display in the Initial Set mode. (See the above topic.)
2. Push [VFO/MR/CALL] several times to select the memory mode or Call channel mode.
  - **For memory channel:**  
Push [▲] or [▼] to select the desired memory channel.
3. Push [FUNC], and then push [SET] to enter the channel name programming mode.
  - A cursor blinks for the first character.
4. Rotate [VOL] to select a character.
  - The selected character blinks.
5. Push [▲] to move the cursor right, push [▼] to move the cursor left.
6. Repeat steps 4 and 5, until the desired channel name is completed.
7. Push [# ENT] to exit the programming mode.

#### Example: Programming “CALL” into memory channel 12.

Push [▲] or [▼] to select channel 12.

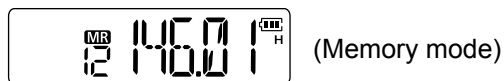

(Memory mode)

Push [FUNC] and then push [SET].

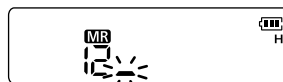

Rotate [VOL] to select the character, and then push [▲] or [▼] to move the cursor.

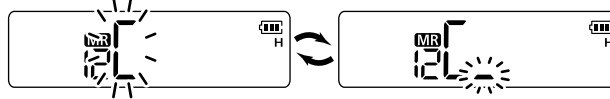

Repeat until the name is complete.

Push [# ENT] to exit the programming mode.



### ◇ Selectable characters

A	b	C	d	E	F	G	H	I	J	k	L	m
(A)	(b)	(C)	(d)	(E)	(F)	(G)	(H)	(I)	(J)	(k)	(L)	(m)
n	O	P	q	R	S	t	U	V	W	X	y	Z
(n)	(O)	(P)	(q)	(R)	(S)	(t)	(U)	(V)	(W)	(X)	(y)	(Z)
1	2	3	4	5	6	7	8	9	0			
(1)	(2)	(3)	(4)	(5)	(6)	(7)	(8)	(9)	(0)			
+	-	=	*	/	[	]	:					
(+)	(-)	(=)	(*)	(/)	([)	(])	(:)	(Space)				

## Section 6      SCAN OPERATION

---

Scan types.....	6-2
◇ VFO scan.....	6-2
◇ Memory scan.....	6-2
◇ Priority watch.....	6-2
Setting skip channels.....	6-3
Scan resume setting.....	6-3

## Scan types

A scan automatically searches for signals, and makes it easier to locate new stations for contact or listening purposes. See the BASIC MANUAL for details.

### ◇ VFO scan

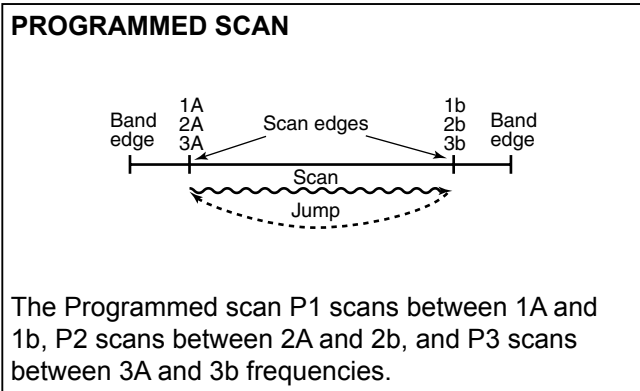
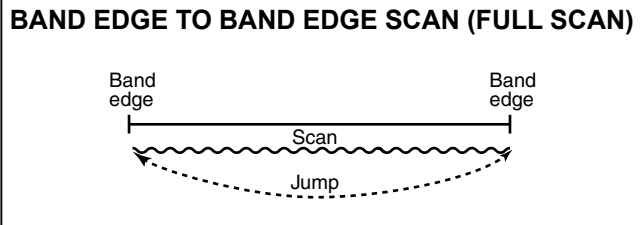

### ◇ Memory scan

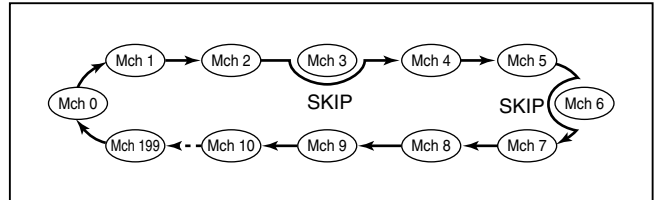

### ◇ Priority watch

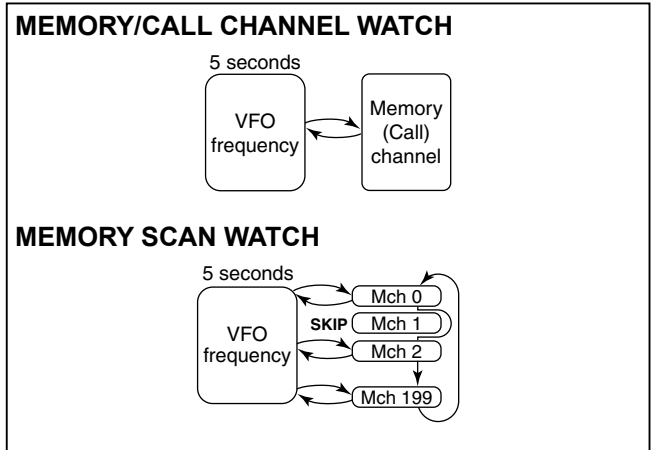



## Setting skip channels

The Memory Skip function speeds up scanning by not scanning those memory channels set as skip channels. Set skip channels as follows.

1. Push [VFO/MR/CALL] several times to select the memory mode.
2. Push [▲] or [▼] to select the memory channel to be skipped.
3. Push [FUNC], and then push [SKIP] to set the channel as a skip channel.
  - “SKIP” is displayed.

### Example: Setting memory channel 11 as the skip channel.

Push ▲ or ▼ to select channel 11.



Push \* [FUNC], and push 6 [SKIP].



Displayed

## Scan resume setting

Various pause and timer options can be selected with the Scan Resume function. The selected resume option is also used for Priority Watch.

1. Push [FUNC], and then push [SET] to enter the Set mode.
2. Push [▲] or [▼] to select the scan pause timer item (SCt, or SCP).
3. Rotate [VOL] to select the desired scan resume option.
  - “SCt. 5/10/15”: Timer scan  
The scan pauses for 5 to 15 seconds, when a signal is received.
  - “SCP. 2”: Pause scan  
The scan pauses, then resumes 2 seconds after the signal disappears.
4. Push [# ENT] to exit the Set mode.

The “Scan pause timer” item in the Set mode



(Pause scan is selected.)



(Timer scan (15 seconds) is selected.)

## Section 7 TONE SQUELCH AND POCKET BEEP

---

Tone/DTCS squelch.....	7-2
◇ Tone squelch and DTCS squelch .....	7-2
◇ Setting tone frequency or DTCS code .....	7-2
◇ Setting DTCS polarity .....	7-2
◇ Operation .....	7-3
Pocket Beep function.....	7-4
Tone scan .....	7-5

## Tone/DTCS squelch

### ◇ Tone squelch and DTCS squelch

The tone squelch or DTCS squelch opens when a signal with the same pre-programmed subaudible tone or DTCS code is received.

#### Recommended CTCSS tones

67.0	79.7	94.8	110.9	131.8	156.7	186.2	225.7
69.3	82.5	97.4	114.8	136.5	162.2	192.8	233.6
71.9	85.4	100.0	118.8	141.3	167.9	203.5	241.8
74.4	88.5	103.5	123.0	146.2	173.8	210.7	250.3
77.0	91.5	107.2	127.3	151.4	179.9	218.1	

#### Recommended DTCS codes

023	051	114	143	174	251	315	371	445	532	631	723
025	054	115	152	205	261	331	411	464	546	632	731
026	065	116	155	223	263	343	412	465	565	654	732
031	071	125	156	226	265	346	413	466	606	662	734
032	072	131	162	243	271	351	423	503	612	664	743
043	073	132	165	244	306	364	431	506	624	703	754
047	074	134	172	245	311	365	432	516	627	712	

### ◇ Setting tone frequency or DTCS code

1. Push [FUNC], and then push [SET] to enter the Set mode.
2. Push [▲] or [▼] to select the CTCSS tone item (Ct) or the DTCS code item (dt).
  - “Ct” blinks when selecting the CTCSS tone item, and “dt” blinks when selecting the DTCS code item.
3. Rotate [VOL] to set the desired tone frequency, or DTCS code.
4. Push [# ENT] to exit the Set mode.

#### The “CTCSS tone” item in the Set mode

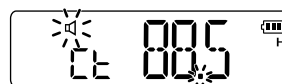

CTCSS tone setting (88.5 Hz is selected.)

#### The “DTCS code” item in the Set mode

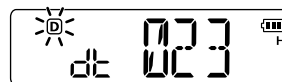

DTCS code setting (023 is selected.)

### ◇ Setting DTCS polarity

For DTCS operation, the polarity setting is also configurable, as well as the code setting. If the polarity is different, the DTCS squelch never opens, even when receiving a signal that includes a matching DTCS code.

1. Push [FUNC], and then push [SET] to enter the Set mode.
2. Push [▲] or [▼] to select the DTCS polarity item (dtP).
3. Rotate [VOL] to select the desired polarity.
  - “dtP.nn”: Normal
  - “dtP.nR”: Normal for TX, reverse for RX
  - “dtP.Rn”: Reverse for TX, normal for RX
  - “dtP.RR”: Reverse
4. Push [# ENT] to exit the Set mode.

#### The “DTCS polarity” item in the Set mode

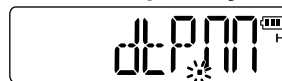

TX and RX: Normal polarity

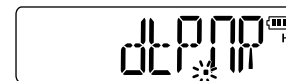

TX: Normal, RX: Reverse

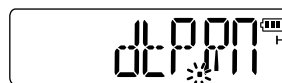

TX: Reverse, RX: Normal

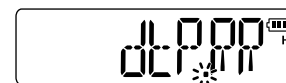

TX and RX: Reverse polarity

Tone/DTCS squelch

◇ Operation

1. Set the operating frequency, or select a memory channel or Call channel.
2. Push [FUNC], and then push [SET] to enter the Set mode.
3. Set the tone frequency, or DTCS code and DTCS polarity.
4. Push [# ENT] to exit the Set mode.
5. Push [FUNC], and then push [TONE] several times, until the icon of desired Tone function is displayed.
  - “J”: Repeater tone encoder
  - “Q” and “U”: CTCSS Pocket Beep function
  - “Q”: CTCSS squelch function
  - “D” and “J”: DTCS encoder (Only TX)
  - “D” and “U”: DTCS Pocket Beep function
  - “D”: DTCS squelch function
- ① When the CTCSS or DTCS squelch function is ON, the tone encoder is activated while transmitting.
6. Operate the transceiver in a normal way; push [PTT] to transmit, release [PTT] to receive.
7. When a signal with matching tones or codes is received, the squelch opens and audio is heard.
  - ① To manually open the squelch, push [MONI].
  - ① If the signal includes an unmatching tones, the squelch does not open. However, the icon shows the strength of the received signal.
8. To cancel the tone or DTCS squelch, push [FUNC], and then push [TONE] several times, until the tone icon disappears.

Push [FUNC], and then push [TONE] to sequentially select the tone function.

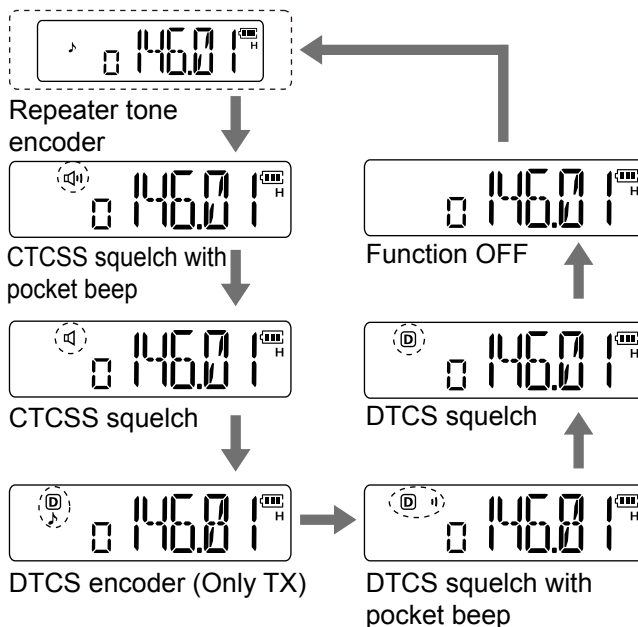

**Squelch burst:**



While using the tone squelch, noise may be heard just when the received signal disappears. To eliminate the noise, the transceiver has the Squelch Burst function. See page 9-7 for details.

## Pocket Beep function

This function uses subaudible tones for calling, and can be used as a “common pager” to inform you that someone has called while you were away from the transceiver.

1. Set the operating frequency, or select the memory channel or Call channel.
2. Push [FUNC], and then push [SET] to enter the Set mode.
3. Set the tone frequency, or DTCS code and DTCS polarity.
4. Push [# ENT] to exit the Set mode.
5. Push [FUNC], and then push [TONE] several times, until the icon of desired Tone function and “i” is displayed.
  - “C” and “i”: CTCSS Pocket Beep function
  - “D” and “i”: DTCS Pocket Beep function
6. When a signal with matching tones or codes is received, beep tones sound and “i” blinks.
 

① To stop the beeps and blinking, push any key.
7. To cancel the tone or DTCS squelch, push [FUNC], and then push [TONE] several times, until the tone icon disappears.

Push , and then push  several times to turn ON the Pocket Beep function.



CTCSS squelch with pocket beep



DTCS squelch with pocket beep

## Tone scan

By monitoring a signal that is being operated with the pocket beep, tone or DTCS Squelch function turned ON, you can determine the tone frequency or DTCS code necessary to open the squelch.

1. Set a frequency or select a memory channel to check for a tone frequency or DTCS code.
2. Push [FUNC], and then push [TONE] several times, until the icon of desired Tone function is displayed.
  - **For a CTCSS tone scan:**  
The scan starts without selecting a tone function.
3. Push [FUNC], and then push [T.SCAN] to start the tone scan.
  - ① To change the scan direction, push [▲] or [▼].
4. When the CTCSS tone frequency or DTCS code is detected, the squelch opens and the detected tone frequency is temporarily programmed into the selected mode.
  - The detected CTCSS tone frequency or DTCS code is used for the tone encoder or decoder, according to the tone condition or type selected in step 2.
    - No icon: Cannot be used for the operation.
    - “♪”: Repeater tone encoder
    - “@” and “♪”: DTCS encoder (Only TX)
    - “♯”: CTCSS tone encoder or decoder
    - “@”: DTCS code encoder or decoder
5. To cancel the scan, push any key except [⏻], [▲]/[▼], [MONI] or [FUNC].

### Example: A DTCS code scan on 145.20 MHz.

Set the operating frequency.

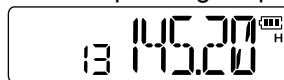

Push [\* FUNC], and then push [1 TONE] several times to select the DTCS squelch function.

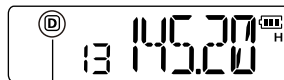

Displayed

Push [\* FUNC], and then push [3 T.SCAN].

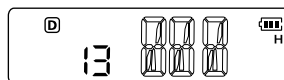

During the DTCS code scan.

## Section 8

## DTMF MEMORY

---

Programming a DTMF code sequence.....	8-2
Transmitting a DTMF code .....	8-3
◇ Selecting the DTMF code transmission option .....	8-3
◇ Manual DTMF code transmission .....	8-3
◇ Using a DTMF memory channel .....	8-3
Monitoring a DTMF memory.....	8-4
Setting DTMF transfer speed .....	8-4

## Programming a DTMF code sequence

DTMF codes are used for autopatching, controlling other equipment, and so on. The transceiver has up to 16 DTMF memory channels (d0–dF) for up to 24 digits often-used DTMF codes.

1. Push [FUNC], and then push [DTMF-M] to enter the DTMF memory mode.
2. Push [▲] or [▼] to select the desired blank DTMF memory channel.
  - The selected DTMF memory channel blinks.
  - If programmed, the previously programmed DTMF code is displayed.

**NOTE:** Previously programmed code sequence in the selected DTMF memory channel will be cleared by the following operation.

3. Push [FUNC], and then hold down [DTMF-M] for 1 second to enter the DTMF memory programming mode.
  - “\_\_\_\_\_” is displayed.
4. Push a key to input the desired DTMF code.
  - Refer to the illustration below for the DTMF code assignment.
  - ① If a digit is mistakenly input, push [PTT] momentarily, and then repeat from step 3.
5. Repeat step 4, until the desired DTMF code sequence (up to 24 digits) is complete.
  - When the 6th character is set, the icon displays the next blank digit group.
6. Push [PTT] to save the channel and exit the DTMF memory programming mode.
  - After the 24th digit is input, the transceiver automatically saves the code sequence and returns to the DTMF memory mode (step 2).
7. Push [VFO/MR/CALL] to exit the DTMF memory mode.

### DTMF code assignment

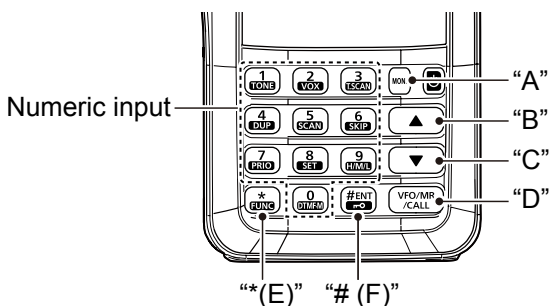

### Example: Programming “123456” into the DTMF memory channel “d3.”

Push [\* FUNC], and then push [0 DTMF-M].

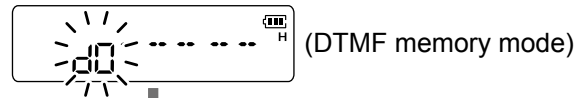

Push [▲] or [▼] to select DTMF memory channel “d3.”



Push [\* FUNC], and then hold down [0 DTMF-M] for 1 second.

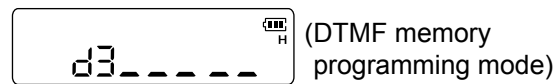

Push keys, until the desired DTMF code is complete.

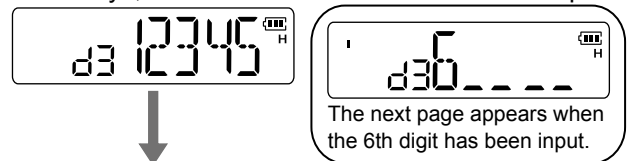

Push [PTT].

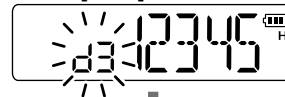

Push [VFO/MR/CALL] to exit the DTMF memory mode.

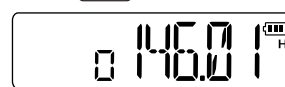

### Programming mode indication

The programming mode consists of 5 groups.

Group	Digits	Icon
1st	1st to 5th	No icon.
2nd	6th to 10th	“ <b> </b> ” is displayed.
3rd	11th to 15th	“ <b>  </b> ” is displayed.
4th	16th to 20th	“ <b>   </b> ” is displayed.
5th	21st to 24th	“ <b>    </b> ” blinks.



## Transmitting a DTMF code

The transceiver has three methods of transmitting a DTMF code sequence. Select the desired option in the Set mode.

### ◇ Selecting the DTMF code transmission option

1. Push [FUNC], and then push [SET] to enter the Set mode.
2. Push [▲] or [▼] to select the DTMF TX key item (dmt).
3. Rotate [VOL] to select the desired option.
  - “dmt.k”: Manual transmission  
Transmits the appropriate DTMF code assigned to the key.
  - “dmt.m”: Using DTMF memory  
Transmits the programmed DTMF code sequence in the DTMF memory channel assigned to the key.
  - “dmt.t”: Only the 1750 Hz tone burst  
No DTMF code can be transmitted. However, while holding down [PTT], pushing either [▲] or [▼] transmits the 1750 Hz tone burst.
4. Push [# ENT] to exit the Set mode.

### The “DTMF TX key” item in the Set mode



Manual transmission



Using DTMF memory



Only 1750 Hz tone burst

### ◇ Manual DTMF code transmission

1. Set the DTMF TX key to “dmt.k” in the Set mode.
2. While holding down [PTT], push the desired keys to manually transmit a DTMF code sequence.

### DTMF code assignment

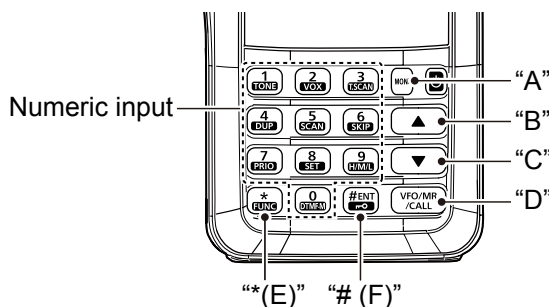

### ◇ Using a DTMF memory channel

1. Set the DTMF TX key to “dmt.m” in the Set mode.
2. While holding down [PTT], push the desired DTMF channel number.

### DTMF memory channel number assignment

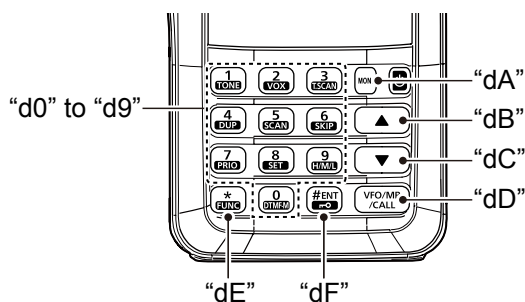

## Monitoring a DTMF memory

You can monitor the programmed DTMF code sequence.

1. Push [FUNC], and then push [DTMF-M] to enter the DTMF memory mode.
2. Push [▲] or [▼] to select the desired DTMF memory channel.
3. Push [MONI] to monitor the DTMF memory contents.
  - The programmed DTMF code sequence sounds, and then the transceiver automatically exits the DTMF memory mode.

### Example: Monitoring DTMF memory channel “d3.”

Push and then push .

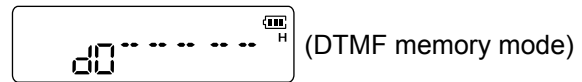

Push or to select DTMF memory channel “d3.”

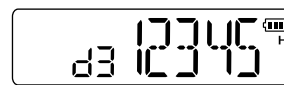

Push [MONI].



The DTMF code sequence sounds.

## Setting DTMF transfer speed

The transmitting speed of DTMF code programmed in the DTMF memory mode can be set to accommodate your operating needs.

1. Hold down for 1 second to turn OFF the transceiver.
2. While holding down and , hold down for 1 second, to turn ON the transceiver to enter the Initial Set mode.
3. Push or to select the DTMF TX speed item (dtd).
4. Rotate [VOL] to select the desired transmitting speed, as shown below.
  - “dtd. 1”: 100 milliseconds interval; 5.0 cps rate
  - “dtd. 2”: 200 milliseconds interval; 2.5 cps rate
  - “dtd. 3”: 300 milliseconds interval; 1.6 cps rate
  - “dtd. 5”: 500 milliseconds interval; 1.0 cps rate

(cps=characters per second)
5. Push [# ENT] to exit the Initial Set mode.

### The “DTMF TX speed” item in the Initial Set mode



(“3” is selected.)

## Section 9 SET MODES

---

Using the Set mode.....	9-2
◇ Set mode operation .....	9-2
Set mode items.....	9-2
Initial Set mode programming.....	9-5
◇ Initial Set mode operation .....	9-5
Initial Set mode items .....	9-5

## Using the set mode

The Set mode is used to change the settings of the transceiver's functions.

**NOTE:** When the display type is "Channel name," you must select the VFO mode to enter the Set mode.

1. Push [FUNC], and then push [SET] to enter the Set mode.
2. Push [▲] or [▼] to select the desired item.
3. Rotate [VOL] to select an option or value.
4. Push [# ENT] to exit the Set mode.

## Set mode items

**NOTE:** The Set mode items contained in the transceiver may be different, depending on the transceiver's version or presetting. Ask your dealer for details.

**NOTE:** When the display type setting is set to "CH" in the Initial Set mode, and you access the Set mode from the memory mode, most of the Set mode items are not displayed.

### Repeater tone frequency

Select the subaudible tone needed to access the repeater. A total of 50 tone frequencies (67.0 ~ 254.1 Hz) are selectable. (Default: 88.5 Hz)

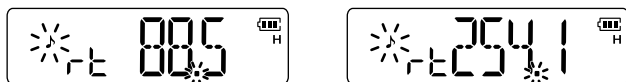

### Tone squelch frequency

Select the CTCSS tone frequency to use for the Tone Squelch function. A total of 50 tone frequencies (67.0 ~ 254.1 Hz) are selectable. (Default: 88.5 Hz)

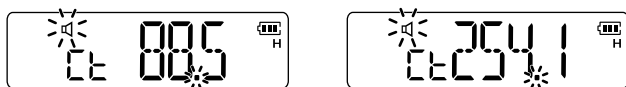

### Usable subaudible tone frequencies (unit: Hz)

67.0	79.7	94.8	110.9	131.8	156.7	171.3	186.2	203.5	229.1
69.3	82.5	97.4	114.8	136.5	159.8	173.8	189.9	206.5	233.6
71.9	85.4	100.0	118.8	141.3	162.2	177.3	192.8	210.7	241.8
74.4	88.5	103.5	123.0	146.2	165.5	179.9	196.6	218.1	250.3
77.0	91.5	107.2	127.3	151.4	167.9	183.5	199.5	225.7	254.1

The transceiver has 50 tone frequencies and consequently their spacing is narrow compared with units having 38 tones. Therefore, some tone frequencies may receive interference from adjacent tone frequencies.

### DTCS Code

Set the DTCS code (both encoder and decoder) for DTCS squelch operation. A total of 104 codes are selectable. (Default: 023)

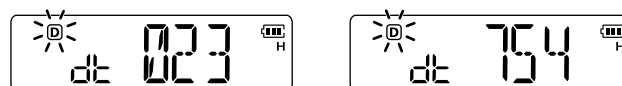

### Available DTCS codes

023	054	125	165	245	274	356	445	506	627	732
025	065	131	172	246	306	364	446	516	631	734
026	071	132	174	251	311	365	452	523	632	743
031	072	134	205	252	315	371	454	526	654	754
032	073	143	212	255	325	411	455	532	662	
036	074	145	223	261	331	412	462	546	664	
043	114	152	225	263	332	413	464	565	703	
047	115	155	226	265	343	423	465	606	712	
051	116	156	243	266	346	431	466	612	723	
053	122	162	244	271	351	432	503	624	731	

### DTCS Polarity

Set the Transmit and Receive DTCS polarity to "NN," "NR," "RN" or "RR." The polarity for transmitting or receiving can be independently set. (Default: dtP.nn)

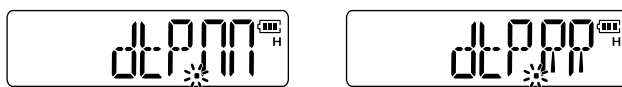

TX/RX: Normal polarity

TX/RX: Reverse polarity

### Frequency offset

Set the duplex frequency offset between 0 and 20 MHz. In the duplex mode, the transmit frequency shifts up or down from the receive frequency by the offset amount. (Default: Differs depending on the transceiver version)

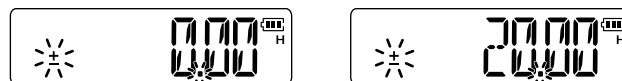

### Reversed Duplex function

Turn the Reversed Duplex function ON or OFF. When the Reversed Duplex function is ON, the receive and transmit frequencies are reversed. (Default: OFF)

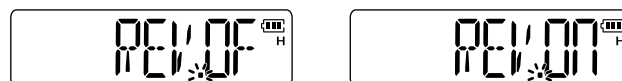

Set mode items

**Tuning step**

Set the VFO tuning step to 5, 10, 12.5, 15, 20, 25, 30, or 50 kHz.  
(Default: Differs depending on the transceiver version)

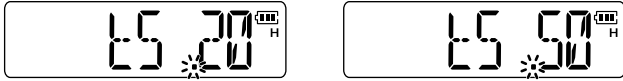

**Scan resume setting**

Select the scan resume option from SCt. 5, SCt. 10, SCt. 15, or SCP. 2. (Default: SCt. 15)

- SCt. 5/10/15: The scan pauses for 5 to 15 seconds, when a signal is received.
- SCP.2: The scan pauses, then resumes 2 seconds after the signal disappears.

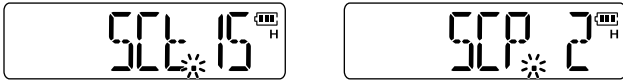

**Function key timer**

Push [FUNC] to enter the Function mode, and then push a keypad key to activate its second function.  
• While in the Function mode, "F" is displayed on the LCD.

Set the time between when the Function mode is entered, and how long it remains activated after you push the keypad key to activate its second function. (Default: F0.At)

- F0.At: Exits the Function mode immediately after a key is pushed to activate its second function.
- F1/2/3.At: The Function mode remains activated 1, 2 or 3 seconds after a key is pushed to activate its second function.
- F.m: The Function mode remains activated until [FUNC] is pushed again, even after a key is pushed to activate its second function.

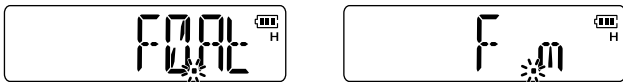

**LCD backlight**

Select the LCD Backlight function. (Default: LIG.At)

- LIG.OF: Turns the backlight function OFF.
- LIG.ON: Lights continuously while the transceiver is ON.
- LIG.At: Turns ON when an operation occurs, and turns OFF after 5 seconds.

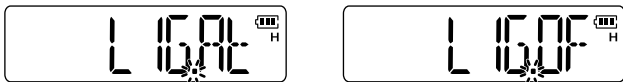

**TX permission**

Select "OFF" to inhibit transmitting on the channel. (Default: tX.ON)

- tX.OF: Transmit is inhibited. (Receive only)
- tX.ON: Transmit is permitted.

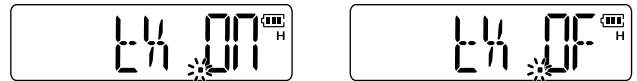

**Weather alert (For only the USA version of IC-V86)**

Turn the Weather Alert function ON or OFF. (p. 16)  
(Default: OFF)

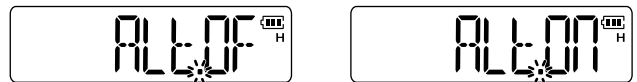

**VOX gain**

Set the VOX gain to between 1 and 10. Higher values make the VOX function more sensitive to your voice.  
To turn OFF the VOX function, select "VOX.OF."  
(Default: VOX.05)

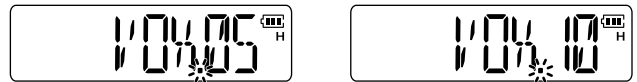

**NOTE:** Set the microphone gain before setting the VOX gain. See page 13-4 for details of the VOX function.

**MIC gain**

Set the microphone gain to between 1 and 4, to suit your preference. Higher values makes the microphone more sensitive to your voice. (Default: mic.2)

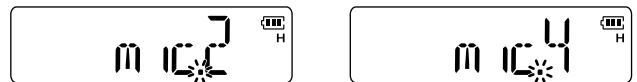

**NOTE:** When using the VOX function, we recommend setting the microphone gain to 3. However, you can adjust it to suit your operating environment (including your headset performance).

**VOX delay**

The VOX Delay is the amount of time the transmitter stays ON after you stop speaking. (Default: VXd.10)

- VXd.05: 0.5 seconds delay
- VXd.10: 1 second delay
- VXd.15: 1.5 seconds delay
- VXd.20: 2 seconds delay
- VXd.25: 2.5 seconds delay
- VXd.30: 3 seconds delay

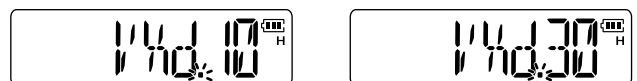

Set mode items

**VOX time-out timer**

Set the VOX time-out timer to between 1, 2, 3, 4, 5, 10, and 15 minutes, to prevent accidental prolonged transmission by the VOX function. To turn OFF the function, select "Vto.OF." (Default: 3)

**The "VOX time-out timer" item in the Set mode**



The VOX time-out timer is set to 3 minutes.



VOX time-out timer is set to 15 minutes (maximum).

The VOX time-out timer must be set shorter than the Time-out timer, otherwise the VOX time-out timer will not function.

**DTMF TX key**

Selects the method to transmit a DTMF code sequence. (Default: dmt.k)

- dmt.k: Transmits the appropriate DTMF code assigned to the key. (p. 8-3)
- dmt.m: Transmits the programmed DTMF code sequence in the DTMF memory channel assigned to the key.
- dmt.t: No DTMF code can be transmitted. (p. 8-3) However, while holding down [PTT], pushing either [▲] or [▼] transmits the 1750 Hz tone burst.



**Mode**

Set both the transmission and reception passband width to wide or narrow. (Default: W/n. W)



Wide (FM mode)



Narrow (FM-N mode)

## Initial Set mode programming

The initial Set mode can be accessed at power ON, and allows you to set seldom-changed settings. In this way, you can “customize” the transceiver to suit your preference and operating style.

### ◇ Initial Set mode operation

1. While holding down [▲] and [▼], hold down [⏻] for 1 second to enter the Initial Set mode.
2. Push [▲] or [▼] to select the desired item.
3. Rotate [VOL] to select an option or value.
4. Push [# ENT] to exit the initial Set mode.

## Initial Set mode items

### Extra High Power

Select whether or not to display and select EXH (Extra High) as the highest power of the transceiver.

(Default: EXH.OF)

- EXH.OF: Displays and selects High as the highest power level of the transceiver.
- EXH.On: Displays and selects Extra High as the highest power level of the transceiver.



### Key-touch beep

Set the confirmation beeps to between 1 and 3.

To turn OFF the confirmation beeps, select “bEP.OF.” (Default: bEP. 2)

- When changing the beep level, beeps sound at the level.



### Time-out timer

To prevent accidental prolonged transmission, the transceiver has a time-out timer. The function inhibits continuous transmissions longer than the set time period (1 ~ 30 minutes). (Default: tot. 5)

- tot.OF: Turns OFF the function.
- tot. 1 ~ 30: Transmission is cut OFF after the set time period ends.



Approximately 10 seconds before the Time-out timer is activated, the transceiver emits a beep tone as a warning.

**BE CAREFUL!** When using the BP-263 BATTERY CASE, the batteries will become hot if this Time-out Timer function is turned OFF or set to a long time period, and transmission is made for long periods.

### Auto Repeater (For only the USA version of IC-V86)

The Auto Repeater function automatically turns the duplex setting and tone encoder ON or OFF when the operating frequency falls within or outside of the general repeater output frequency range (145.200 ~ 145.495 MHz, 146.610 ~ 146.995 MHz, and 147.000 ~ 147.395 MHz). The frequency offset and repeater tone frequency are not changed by the Auto Repeater function; reset these frequencies, if necessary.

(Default: RPt.R1)

- RPt.OF: Turns OFF the function.
- RPt.R1: Activates only duplex.
- RPt.R2: Activates duplex and tone.



### Auto power-OFF

The transceiver can be automatically turned OFF, when no key operation is performed for the specified period of time. 30 minutes, 1 hour, 2 hours and OFF are selectable.

(Default: POF.OF)

- POF.OF: Turns the function OFF.
- POF.30/1H/2H: The transceiver is automatically turned OFF, when no key operation is performed for the specified time period.



**NOTE:** The setting is retained, even if the transceiver is turned OFF by the Auto Power OFF function. To cancel the function, select “POF.OF.”

Initial Set mode items

**Lockout**

Set the transmission lockout (temporary transmission inhibit) capability. (Default: RLO.OF)

- RLO.OF: Turns OFF the function.
- RLO.RP: The transmit is inhibited when a signal with an unmatching subaudible tone is received.
- RLO.bU: Transmit is inhibited when a signal is received.



**Squelch delay**

Set the squelch delay to short or long. The delay prevents the squelch from repeatedly opening and closing, while receiving the same signal.

(Default: Sqd. S)

- Sqd. S: Short squelch delay.
- Sqd. L: Long squelch delay.



**DTMF speed**

Set the rate at which DTMF memories send individual DTMF characters to accommodate your operating needs. (Default: dtd. 1)

- dtd. 1: 100 milliseconds interval: 5.0 cps rate
  - dtd. 2: 200 milliseconds interval: 2.5 cps rate
  - dtd. 3: 300 milliseconds interval: 1.6 cps rate
  - dtd. 5: 500 milliseconds interval: 1.0 cps rate
- (cps=characters per second)



**Dial assignment**

Selects whether or not to use [VOL] as a tuning control or channel selector, instead of [▲] and [▼]. When [VOL] functions as a tuning control or channel selector, [▲] and [▼] function as volume controls.

(Default: tOP.VO)

Option	[VOL]	[▲]/[▼]
tOP.VO	Volume control	Tuning controls
tOP.di	Tuning control	Volume controls



**Display type**

Set the display type for memory mode operation.

(Default: dSP.FR)

- dSP.FR: Displays the programmed frequency.
- dSP.CH: Displays only the memory channel number.

**NOTE:** Only the following functions can be used.

- Scan function
- Setting output power
- DTMF Memory function
- Key Lock function
- Setting of following items in the Set mode (pp. 9-2 ~ 9-4):  
Scan resume setting, Function key timer, LCD backlight, VOX gain, MIC gain, VOX delay, VOX time-out timer, and DTMF TX key.

- dSP.nm: Displays the channel name. If no memory name is programmed, the programmed frequency will be displayed.



**LCD contrast**

Selects the LCD contrast.

(Default: Lcd.At)

- Lcd.LO: Sets the contrast to low.
- Lcd.At: Sets the contrast to high. However, if the transceiver is exposed to high temperatures, it automatically sets the contrast to low.



**Power save**

The Power Save function enables you to conserve battery life by selecting the duty cycle of the receiver. Select the ratio of the power save time to the standby time. To turn OFF the function, select "P-S.OF."

(Default: P-S.At)

- P-S.OF: Turns OFF the function.
- P-S. 2: Sets the duty cycle to 1:2. (ON: 0.1 second, OFF: 0.2 seconds)
- P-S. 8: Sets the duty cycle to 1:8. (ON: 0.1 second, OFF: 0.8 seconds)
- P-S.16: Sets the duty cycle to 1:16. (ON: 0.1 second, OFF: 1.6 seconds)
- P-S.At: Automatically sets the duty cycle. When no operation occurs and no signal is received for 5 seconds, the transceiver enters the Power Save mode, and sets "1:2" as the duty cycle, and after 60 seconds, it sets "1:16" as the duty cycle.

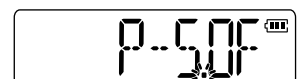
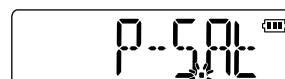



Initial Set mode items

**Select speed**

Selects whether or not to accelerate the turning speed when rotating [VOL] rapidly. (Default: S-S. At)

- S-S. m: Turns OFF the tuning speed acceleration.
- S-S. At: The turning speed is automatically accelerated when rapidly rotating [VOL].

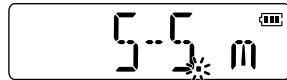
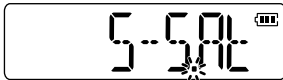

**Microphone simple mode**

Microphone Simple mode is used to assign the essential operations to the four switches (S1 to S4) on the remote control unit. (Default: mS .n1)

- mS .Sm

S1	Selects the Call channel.
S2	Turns the Monitor function ON or OFF.
S3	Selects memory channel 0.
S4	Selects memory channel 1.

- mS .n1

S1	Toggles the VFO mode and the memory mode.
S2	Selects the Call channel.
S3	Frequency or memory channel up.
S4	Frequency or memory channel down.

- mS .n2

S1	Toggles the VFO mode and the memory mode.
S2	Turns the Monitor function ON or OFF.
S3	Frequency or memory channel up.
S4	Frequency or memory channel down.



**User remote control unit**

The circuit illustrated below is for only reference.

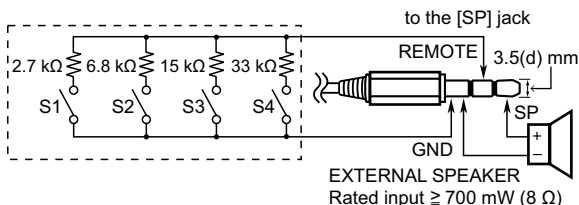

**Voltage Indication**

The voltage of the battery is displayed at power ON. This display can be turned ON or OFF. (Default: VLt.On)

- VLt.OF: The battery voltage display is skipped.
- VLt.On: The battery voltage is displayed at power ON.



**Battery protection function**

When the battery voltage decreases, the Battery Protection function automatically turns OFF the transceiver. Select the function option according to your battery type. (Default: Differs depending on the transceiver version)

- bAt.OF: Turns OFF the function. Select when you use the BP-263 battery case.
- bAt.nm: Select when you use the BP-264 Ni-MH battery pack.
- bAt.LI: Select when you use the BP-298/BP-299 Li-ion battery pack.



**NOTE: BE SURE** to select an appropriate option according to your battery type.

**Auto low power**

Turns the Automatic Low-power function ON or OFF. When the temperature goes below 0°C (+32°F), the function automatically sets the output power to low. In that case, the transmit power selections (High or Mid) are also disabled. (default: ALP.OF)

- ALP.OF: The auto low power is OFF.
- ALP.On: The auto low power is ON.



**NOTE:** This item is activated when the Battery protection function is set to “bAt.nm” or “bAt.LI.”

**Squelch burst**

The squelch burst function stops transmitting a subaudible tone before your transceiver stops transmitting RF, to eliminate noise. The squelch burst will be effective only when the other station uses the tone squelch function. (Default: Sqb.OF)

- Sqb.OF: The squelch burst is OFF.
- Sqb.On: The squelch burst is ON.



# Section 10 PROGRAMMING

---

Programming operation.....	10-2
◇ Programming between two transceivers.....	10-2
◇ Programming using a PC.....	10-2

## Programming operation

Programming allows you to quickly and easily transfer the programmed contents from one transceiver to another, or data between a personal computer and a transceiver, using the optional CS-V86 PROGRAMMING SOFTWARE.

### ◇ Programming between two transceivers

1. Turn OFF the transceivers, and then connect the master and Sub transceivers using the OPC-474 PROGRAMMING CABLE through their speaker jacks.
  - ① The Master transceiver is used to send data to the Sub transceiver.
2. While holding down [FUNC] and [▲], turn ON the master transceiver to enter the programming mode.
  - “CLOnE” is displayed.
3. Turn ON the Sub transceiver.
4. Push [PTT] on the Master transceiver.
  - “CL Out” is displayed on the Master transceiver’s display, and the signal icon shows that data is being transferred to the Sub transceiver.
  - “CL In” is displayed on the Sub transceiver’s display, and the signal icon shows that data is being received from the Master transceiver.
5. When the programming is finished, turn OFF both transceivers, and then turn ON the transceivers again to exit the programming mode.

#### NOTE:

- **DO NOT** push [PTT] on the Sub transceiver during programming. This will cause an error.
- **DO NOT** disconnect the programming cable or turn OFF the transceivers during programming. This will cause an error.

### ◇ Programming using a PC

Data can be transferred to and from a PC, using the optional CS-V86 PROGRAMMING SOFTWARE and an OPC-478UC (USB type) PROGRAMMING CABLE. Consult the INSTRUCTIONS and the Help file that come with the programming software, for details.

**CAUTION: BE SURE** to turn OFF the power, before connecting or disconnecting optional equipment to or from the [SP MIC] jack.

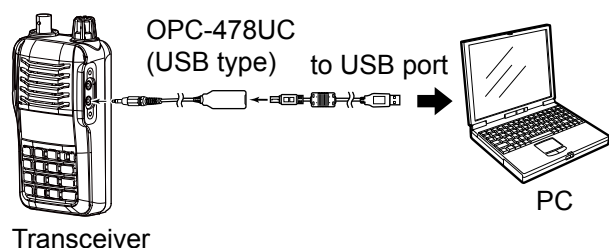
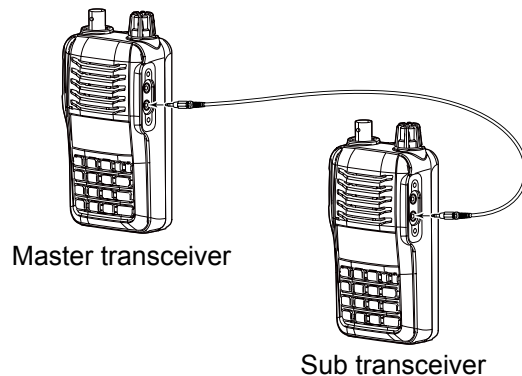

# Section 11    RESETTING

---

Resetting ..... 11-2

## Resetting

The LCD may occasionally display erroneous information (Example: when first applying power). This may be caused externally by static electricity or by other factors.

### ◇ All reset

The all reset clears all programming and returns all settings to their factory defaults.

1. Hold down [⏻] for 1 second to turn OFF the transceiver.
2. While holding down [MONI] and [VFO/MR/CALL], hold down [⏻] for 1 second to turn ON the power.
  - “CLEAR” is displayed when the transceiver is totally reset.

**CAUTION:** The All reset returns all programmed contents to their default settings.

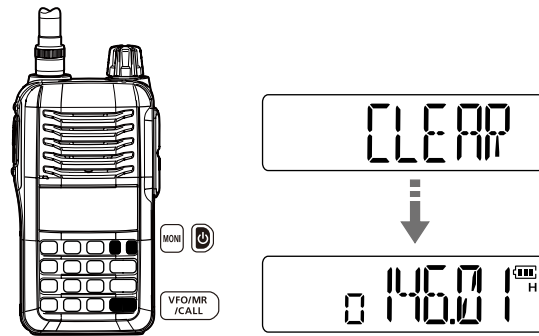

# Section 12 TROUBLESHOOTING

---

Troubleshooting.....12-2

### Troubleshooting

#### No power comes ON.

- The battery is exhausted.  
→ Charge the battery pack, or replace the batteries. (pp. 2-2 ~ 2-3 , 13-3)
- The battery polarity is reversed.  
→ Check the battery polarity. (p. 13-3)
- Bad connection of a battery pack or case.  
→ Clean battery terminals. (p. 13-3)

#### No sound comes from the speaker.

- Volume level is too low.  
→ Rotate [VOL] to adjust to the volume level.
- Squelch level is too high.  
→ While holding down [MONI], push [▲] or [▼] several times to adjust the squelch level.  
① Use [VOL] or [▲] or [▼], depending on the setting of the "Dial assignment" in the Initial Set mode.
- An external speaker or a programming cable is connected to the [SP] jack.  
→ Check the external speaker connection or remove the programming cable.

#### Transmitting is impossible.

- The battery is exhausted.  
→ Charge the battery pack, or replace the batteries. (pp. 2-2 ~ 2-3 , 13-3)
- Transmission is inhibited.  
→ Set the 'TX permission' item to "ON" in the Set mode. (p. 9-3)
- The Lockout function is activated.  
→ Wait to transmit until receiving an unmatched tone or a signal is stopped.

#### Transmitting using the VOX function is impossible.

- The VOX gain is set to OFF or too low.  
→ Set the VOX gain to a suitable level. (p. 13-5)
- The microphone gain is too low.  
→ Set the microphone gain to a suitable level. (p. 9-3)
- Transmission is inhibited.  
→ Set the 'TX permission' item to "ON" in the Set mode. (p. 9-3)

#### No direct contact possible with other stations.

- A different tone or code is used for the tone or DTCS squelch.  
→ Check the tone or DTCS code by the tone scan. (p. 7-5)

#### Frequency cannot be set.

- The Key Lock function is activated.  
→ Push [FUNC], and then hold down [r-O] for 1 second to cancel the Key Lock function.
- The memory mode, Call channel mode, or weather channel mode\* is selected.  
→ Push [VFO/MR/CALL] several times to select the VFO mode.

#### A programmed scan does not start.

- The memory mode, Call channel mode, or weather channel mode\* is selected.  
→ Push [VFO/MR/CALL] several times to select the VFO mode.
- The same frequency has been programmed in the scan edge channels, "XA"–"Xb."  
→ Program different frequencies as the scan edge channels.

#### A memory scan does not start.

- The memory mode is not selected.  
→ Push [VFO/MR/CALL] several times to select the memory mode.
- Only one or no memory channel has been programmed.  
→ Program 2 or more memory channels.

#### The function display shows erroneous information.

- The CPU is malfunctioning.  
→ Reset the CPU. (p. 11-2)
- External factors have caused a fault.  
→ Remove and reattach the battery pack or case. (p. 1-3)

\* For only the USA version of IC-V86.

# Section 13    OPTIONS

---

Options .....	13-2
◇ Battery packs/Battery case .....	13-2
◇ Chargers .....	13-2
◇ DC cables .....	13-2
◇ Antennas .....	13-2
◇ Others .....	13-2
Optional battery case (BP-263) .....	13-3
VOX function .....	13-4
◇ Optional unit connection .....	13-4
◇ Turning the VOX function ON or OFF .....	13-4
◇ VOX-related settings.....	13-5



## Options

### ◇ Battery packs/Battery case

- **BP-263** BATTERY CASE
- **BP-264** Ni-MH BATTERY PACK
- **BP-298/BP-299** Li-ion BATTERY PACK

Battery pack	Voltage	Capacity	Battery life*1	
<b>BP-263</b>	Battery case for AA (LR6) × 6 alkaline cells		—*2	
<b>BP-264</b>	7.2 V	1400 mAh (min.) 1420 mAh (typ.)	EXH	12.5 hours
			H	13 hours
<b>BP-298</b>	7.2 V	2100 mAh (min.) 2250 mAh (typ.)	EXH	19 hours
			H	20.5 hours
<b>BP-299</b>	7.2 V	3050 mAh (min.) 3150 mAh (typ.)	EXH	27 hours
			H	29 hours

\*1 When the Power Save function is set to "P-S.16" (p. 9-6), and the operating time is calculated under the following ratio:  
TX : RX : standby = 5 : 5 : 90

(3 seconds : 3 seconds : 54 seconds)

\*2 The average operating life depends on the alkaline cells used.

Even when the transceiver power is OFF, a small amount of current still flows in the transceiver. Remove the battery pack or case when it will not be used for a long time. Otherwise, the battery pack or the batteries in the case will become exhausted.

### ◇ Chargers

① A power adapter may be supplied with the charger, depending on the charger version.

- **BC-191** DESKTOP CHARGER  
To rapidly charge the BP-264 Ni-MH BATTERY PACK.
- **BC-192** DESKTOP CHARGER  
To regularly charge the BP-264 Ni-MH BATTERY PACK.
- **BC-240** DESKTOP CHARGER  
To rapidly charge the BP-298/299 Li-ion BATTERY PACK.
- **BC-197** MULTI CHARGER  
To rapidly charge the BP-264 Ni-MH BATTERY PACKS.  
The AD-120 CHARGER ADAPTERS are installed.
- **BC-214N** MULTI CHARGER  
To rapidly charge the BP-298/299 Li-ion BATTERY PACKS.  
The AD-139 CHARGER ADAPTERS are installed.

### ◇ DC cables

- **CP-23L** CIGARETTE LIGHTER CABLE  
Use when charging the battery pack from a 12 V cigarette lighter socket.  
(For the BC-191, BC-192, and BC-240)
- **OPC-515L/OPC-656** DC POWER CABLE  
Use when charging battery packs using a 13.8 V DC power source instead of the power adapter.  
OPC-515L: For the BC-191, BC-192, and BC-240  
OPC-656: For the BC-197 and BC-214N

### ◇ Antennas

- **FA-B45V/FA-B57V** VHF ANTENNA  
FA-B45V: 144 ~ 148 MHz  
FA-B57V: 160 MHz
- **FA-B57U/FA-B03U** UHF ANTENNA  
FA-B57U: 430 ~ 450 MHz  
FA-B03U: 330 ~ 380 MHz

### ◇ Others

- **MB-124** BELT CLIP
- **MB-130** CHARGER BRACKET  
Mounts the BC-191, BC-192 and BC-240 BATTERY CHARGERS on a variety of places in a vehicle.
- **HM-158LA/HM-159LA/**  
**HM-168LWP/HM-222HLWP\*** SPEAKER MICROPHONE  
Combination speaker microphone that provides convenient operation while the transceiver is hanging on your belt.  
① Adjust the microphone gain before use.

\* High audio output is only usable with transceivers that support the function. (With a "U" mark on the serial number label)

- **HM-153LA/HM-166LA** EARPHONE MICROPHONE  
Ideal for hands-free operation. Clip the HM-153LA or HM-166LA (with integrated PTT switch) to your lapel or breast pocket.  
① Adjust the microphone gain before use.
- **HS-94/HS-95/HS-97** HEADSET  
**+VS-4LA** PTT SWITCH CABLE/**OPC-2004LA** ADAPTER CABLE  
HS-94: Ear-hook type  
HS-95: Neck-arm type  
HS-97: Throat microphone  
VS-4LA: To connect to headsets  
OPC-2004LA: To connect to headsets for VOX operation.  
① Adjust both the microphone and VOX gain before use.
- **HS-94LWP/HS-95LWP** HEADSET  
HS-94LWP: Ear-hook type  
HS-95LWP: Neck-arm type  
① Adjust both the microphone and VOX gain before use.
- **CS-V86** PROGRAMMING SOFTWARE  
**+OPC-478UC** PROGRAMMING CABLE  
Provides quick and easy programming of such settings as memory channels and Set modes contents.
- **OPC-474** PROGRAMMING CABLE  
For transceiver-to-transceiver programming.

Some options may not be available in some countries. Ask your dealer for details.

## Optional battery case (BP-263)

When using the battery case (BP-263), install 6 × AA (LR6) size alkaline batteries, as described below.

1. Remove the battery case, if it is attached.
  - ① The procedure of removing the battery case is same as the battery pack. (p. 1-3)
2. Install 6 × AA (LR6) size alkaline batteries.
  - ① Install only alkaline batteries.
  - ① Be sure to observe the correct polarity.
3. Attach the battery case.
  - ① The procedure of attaching the battery case is same as the battery pack. (p. 1-3)

### ⚠ WARNING!

- Never incinerate used battery cells since the internal battery gas may cause them to rupture.
- Never expose a detached battery case to water. If the battery case gets wet, be sure to wipe it dry before using it.

### CAUTION:

- When installing batteries, make sure they are all the same brand, type and capacity. Also, do not mix new and old batteries together.
- Keep battery terminals clean. It's a good idea to occasionally clean them.
- Never use batteries whose insulated covering is damaged.

**CAUTION:** When the battery case is attached, the Battery Protection function must be turned OFF in the Initial Set mode. (p. 9-7 )

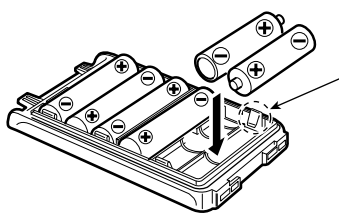

**BE CAREFUL!** The negative terminals of the battery case protrude from the body, so pay attention not to injure your fingers when inserting the batteries.

## VOX function

The transceiver has a VOX function, which allows hands-free operation.

An optional HS-94, HS-95 or HS-97 HEADSET and the VS-4LA PTT SWITCH CABLE or OPC-2004LA ADAPTER CABLE are also required for operation.

### What is VOX?

The VOX (voice operated transmission) function starts transmission when you speak into the microphone, without pushing [PTT], and then automatically returns to reception when you stop speaking.

### Optional unit connection

1. Hold down [⏻] for 1 second to turn OFF the power.
2. Remove the jack cover. (p. 1-3)
3. Connect the optional HS-94, HS-95 or HS-97 and VS-4LA or OPC-2004LA.

**CAUTION: DO NOT** use the transceiver without the connector cover or the optional microphone attached. The transceiver meets IP54 requirements for dust protection and splash resistance only when the connector cover or the optional microphone is attached.

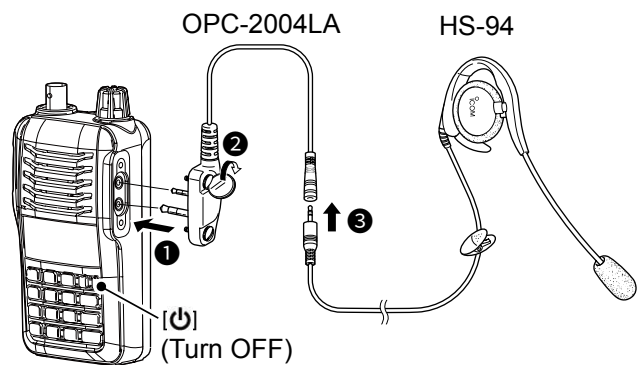

### Turning the VOX function ON or OFF

1. Connect an optional headset and plug adapter cable to the transceiver, and then turn ON the power.
2. Push [FUNC], and then push [VOX] to turn the VOX function ON or OFF.
  - "VOX" is displayed when the VOX function is ON.

#### NOTE:

- When using the VOX function, adjust the microphone gain and the VOX-related settings (p. 13-5) to suit your operating environment (including your headset performance).
- Set the microphone gain before setting the VOX gain in the Set mode. (p. 9-3)  
We recommend setting the microphone gain to 3.
- When 'TX permission' is set to "OFF" in the Set mode (p. 9-3), you cannot transmit using the VOX function.

Push [FUNC], and then push [VOX].

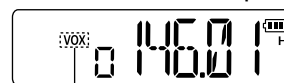

Displayed

VOX function

◇ VOX-related settings

The VOX gain, VOX delay, and VOX time-out timer are set in the Set mode.

1. Connect an optional headset and plug adapter cable to the transceiver, and then turn ON the power.
2. Push [FUNC], and then push [VOX] to turn ON the VOX function.
3. Push [FUNC], and then push [SET] to enter the Set mode.
4. Push [▲] or [▼] to select the VOX gain (VOX), VOX delay (VXd), or the VOX time-out timer (Vto) item.
5. Rotate [VOL] to select an option.
6. Push [# ENT] to exit the Set mode.

The VOX function is not activated while in the Set mode.

**VOX gain**

The VOX gain level can be adjusted between 1 (minimum) and 10 (maximum), or turned OFF. Higher values make the VOX function more sensitive to your voice. (Default: VOX.05)

- While speaking into the headset microphone, adjust the VOX gain until “On” continuously is displayed on the display.

If “On” is intermittent, be sure the VOX delay is set long enough to allow normal pauses in speech, but keep the VOX ON until you finish speaking.

**CONVENIENT!**

While transmitting using the VOX function, you can adjust the VOX gain simply by rotating [VOL].

**VOX delay**

Set the VOX delay to between 0.5 and 3.0 seconds (in 0.5 seconds steps). The VOX delay is the amount of time the transmitter stays ON after you stop speaking. (Default: VXd.10)

**VOX time-out timer**

Set the VOX time-out timer to between 1, 2, 3, 4, 5, 10 and 15 minutes to prevent accidental prolonged transmission for the VOX function. To turn OFF the function, select “Vto.OF.” (Default: 3)

The VOX time-out timer must be set shorter than the time-out timer, otherwise the VOX time-out timer will not function.

Push , and then push .



Displayed

**The “VOX gain” item in the Set mode**



The VOX function is turned OFF.



The VOX gain is set to 10 (max.).



Displayed

**The “VOX delay” item in the Set mode**

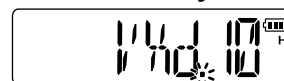

The VOX delay is set to 1 second.

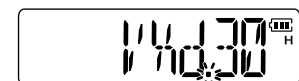

The VOX delay is set to 3 seconds.

**The “VOX time-out timer” item in the Set mode**

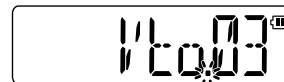

The VOX time-out timer is set to 3 minutes.

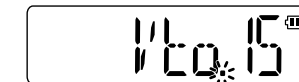

VOX time-out timer is set to 15 minutes (maximum).

