

DS-D5022FN10 21.5 inch FHD Borderless Monitor



- Ultra-thin device body with ultra-thin border for 3 sides.
- 8 bit LVDS HD (1920 × 1080) display.
- 178° ultra-wide view screen.
- 3D noise reduction.
- Low blue light design for eye care.
- Dual interface of HDMI and VGA.
- Supports VESA wall mount.

▪ Specification

Model		DS-D5022FN10
Display	Screen Size	21.5 inch
	Active Display Area	478.656 mm × 260.280 mm
	Resolution	1920 × 1080@60 Hz
	Backlight	E-LED
	Pixel Pitch	0.0831 mm (H) × 0.241 mm (V)
	Brightness	250 cd/m ²
	Viewing Angle	178° (H) / 178° (V)
	Color Depth	8 bit
	Contrast Ratio	3000 : 1
	Response Time	6.5 ms
	Refresh Rate	60 Hz
	Haze	Haze 25%, 3H
	Reliability	7 × 16 H
	Color Gamut	72% NTSC
Interface	Video & Audio Input	HDMI 1.4 × 1, VGA × 1
	Video & Audio Output	None
	Data Transmission Interface	None
	Control Interface	None
Power	Power Supply	DC 12V , 2.0 A
	Power Consumption	≤ 24W
	Standby Consumption	≤ 0.5 W
Working Environment	Working Temperature	0 °C to 40 °C (32 °F to 104 °F)
	Working Humidity	10% to 90% RH (Non-Condensing)
	Storage Temperature	-20 °C to 60 °C (-4 °F to 140 °F)
	Storage Humidity	0% to 90% RH
General	Casing Material	Plastic
	VESA	75 mm × 75 mm (4 - M4 × 6 mm)
	Bezel Width	6.85 mm (top/left/right), 21.55 mm (bottom)
	Product Dimensions (W × H × D)	492.4 mm × 365.4 mm × 162.7 mm (19.4 × 14.4 × 6.4 inch)
	Package Dimensions (W × H × D)	599 mm × 393 mm × 109 mm (23.6 × 15.5 × 4.3 inch)
	Net Weight	2.08 ± 0.5 kg (4.6 ± 1.1 lb.)
	Gross Weight	3.4 ± 0.5 kg (7.5 ± 1.1 lb.)
	Packing List	Monitor × 1, Base component × 1, Power adapter (12 V, 2.0 A) × 1, HDMI cable (1.5 m) × 1, User manual × 1, Multilingual manual × 1
Remarks	If the appearance and parameters in this specification vary from the actual product, the later prevails. You can also consult local sale staff.	

Physical Interface

Interface	Description	Interface	Description
HDMI	HDMI 1.4 digital signal input interface	VGA	VGA analog signal input interface
DC	12 VDC, 2.0 A		

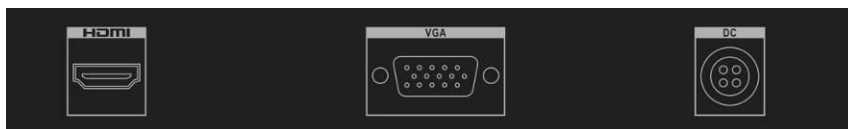

Available Model

DS-D5022FN10

Dimension

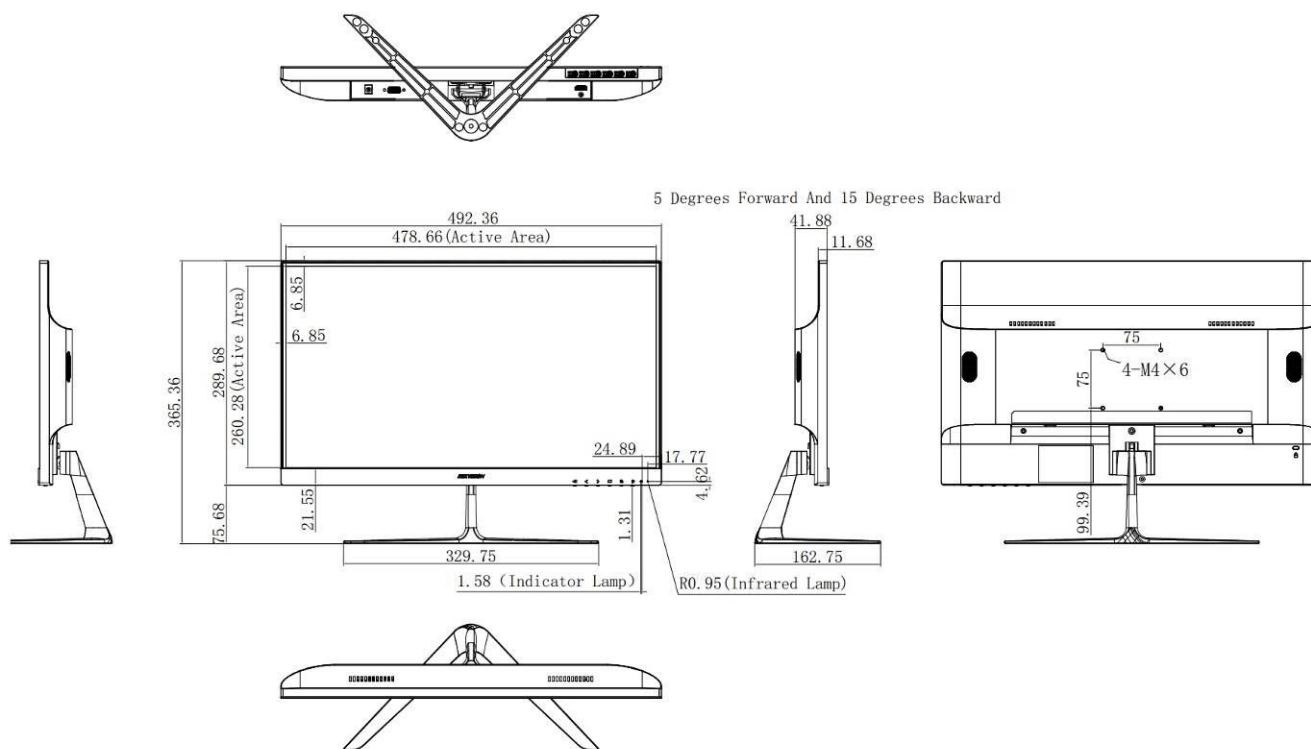

Unit: mm

Headquarters

No.555 Qianmo Road, Binjiang District,
Hangzhou 310051, China
T +86-571-8807-5998
www.hikvision.com



Follow us on social media to get the latest product and solution information.

